

F-1	1531	395	16	x1	1/2
F-2	1531	395	16	x1	1/2
F-3	352	394	16	x1	1/2
F-4	352	394	16	x1	1/2
F-5	352	345	16	x1	1/2
F-6	352	345	16	x1	1/2
F-7	482	335	16	x1	1/2
F-8	346	496	16	x1	1/2
F-9	346	496	16	x1	1/2
F-10	1512	366	3	x1	1/2

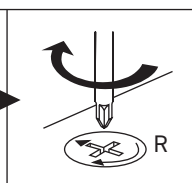

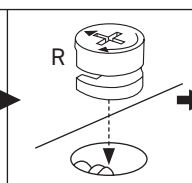

1

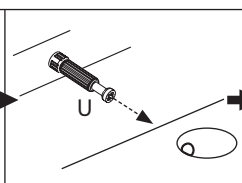
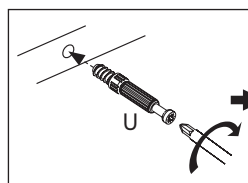
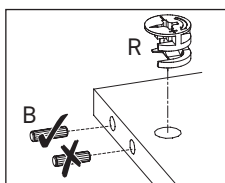
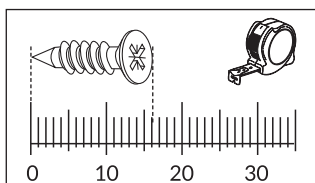
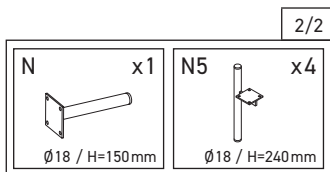
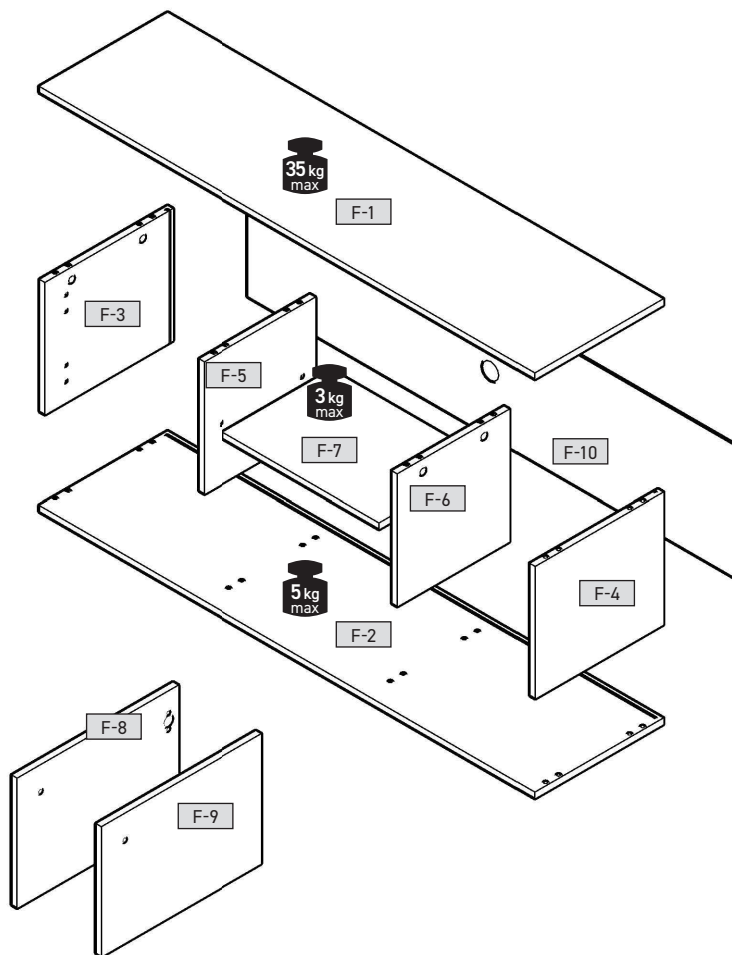
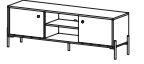
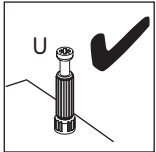
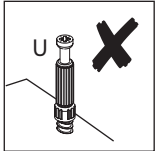
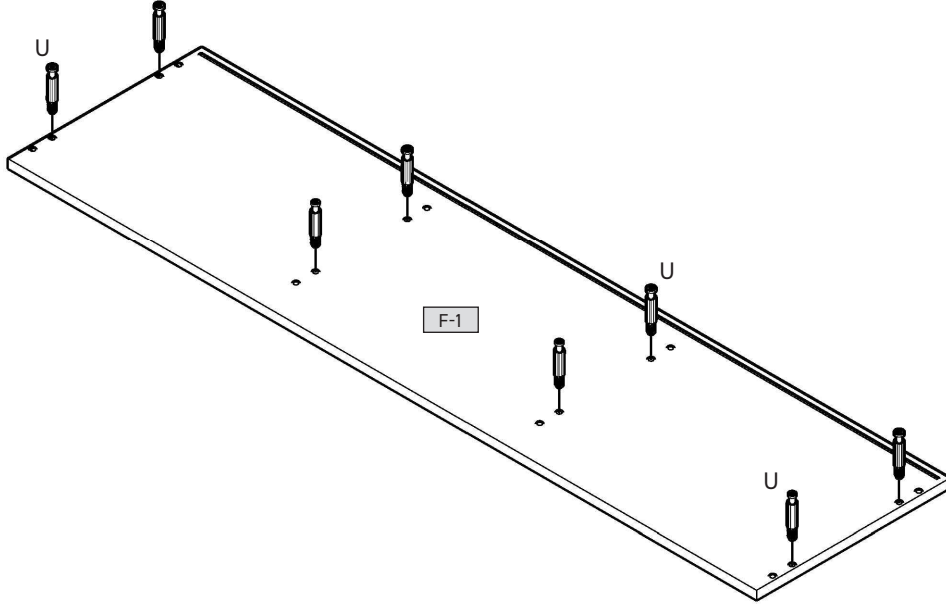
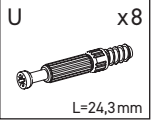

2

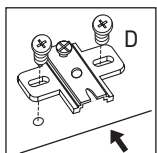
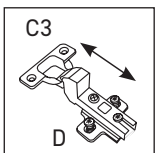
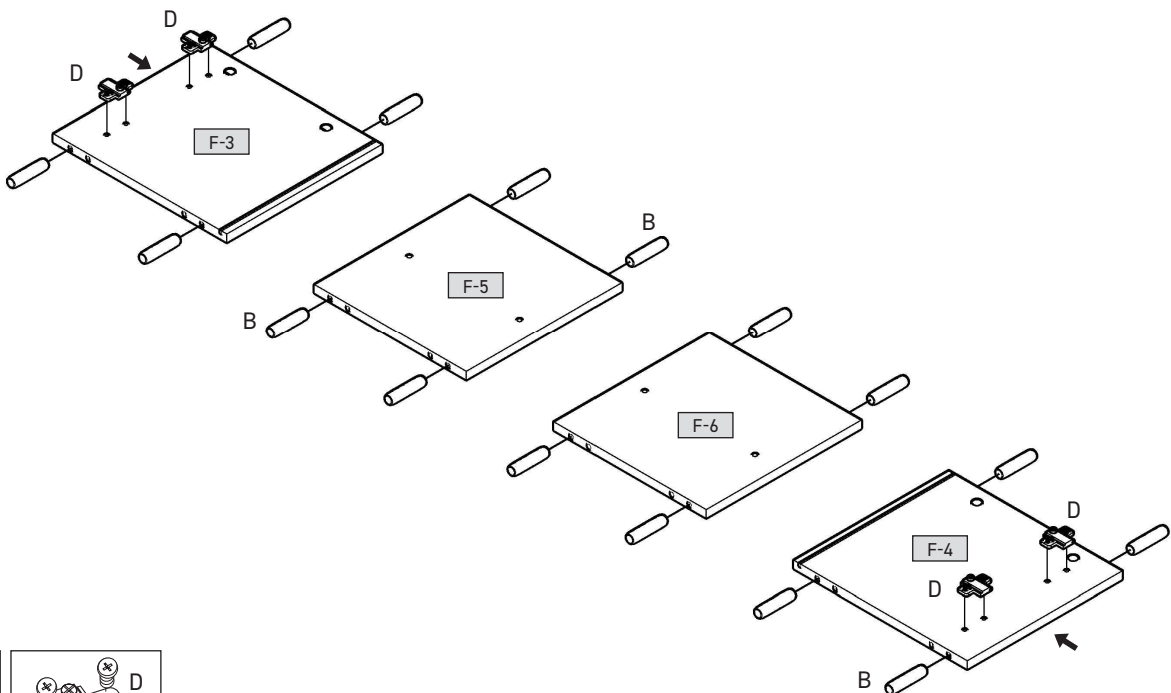
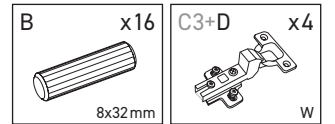

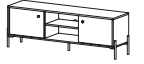

3

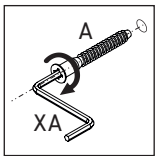
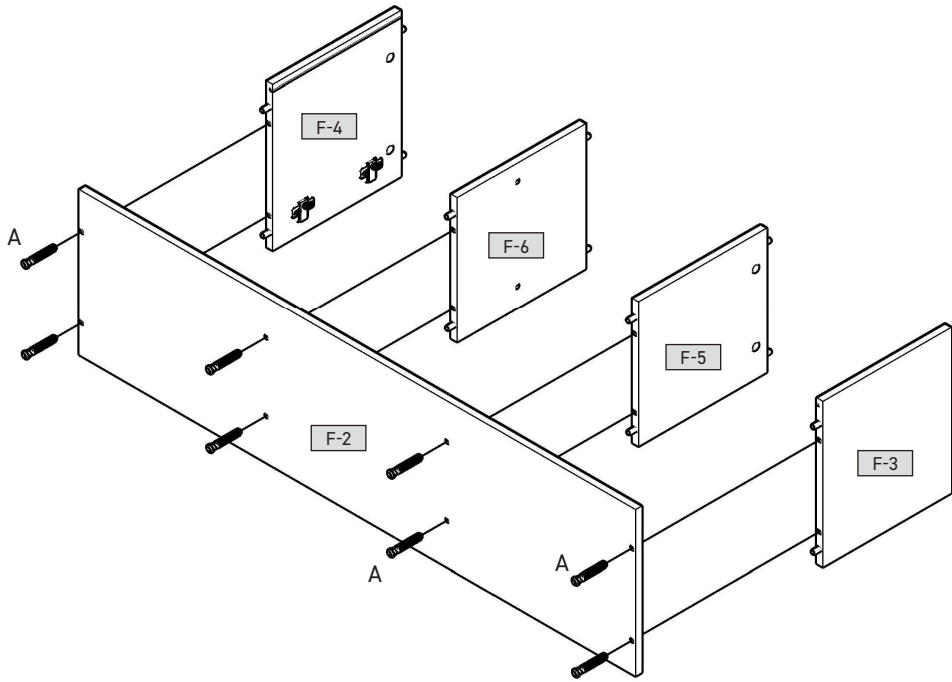
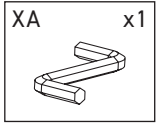
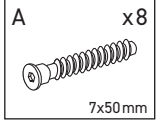

4

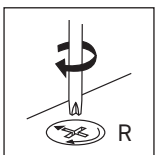
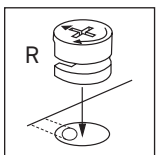
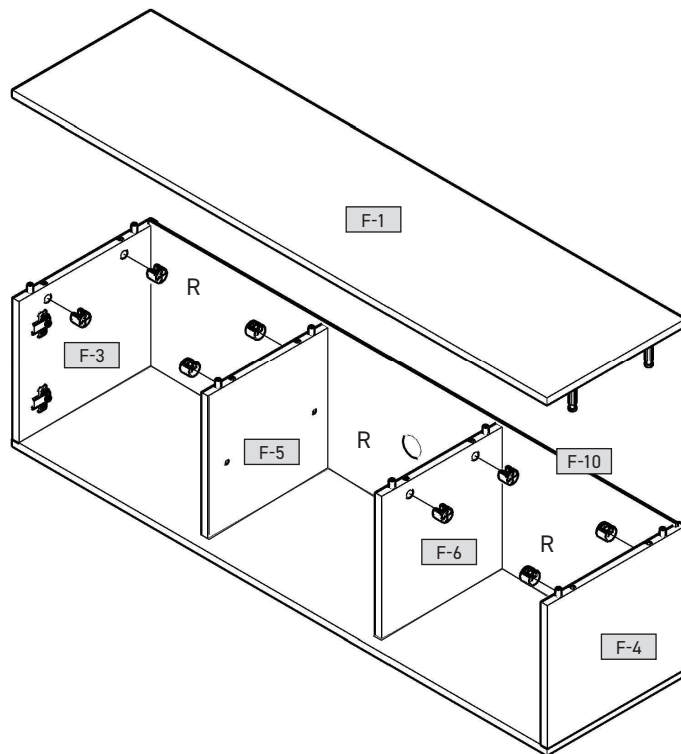
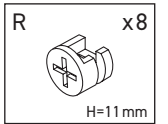



5

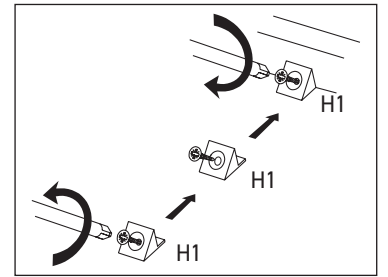
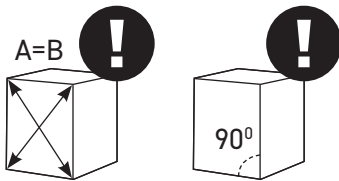
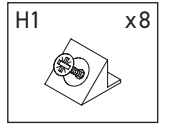
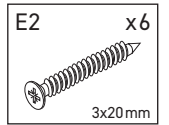
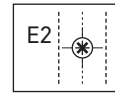
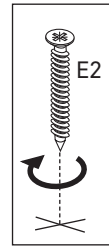
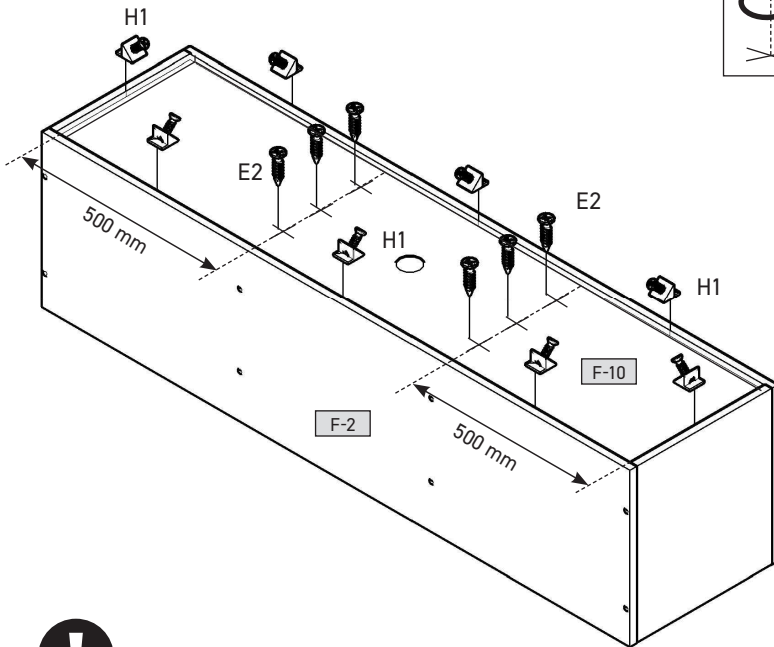

6

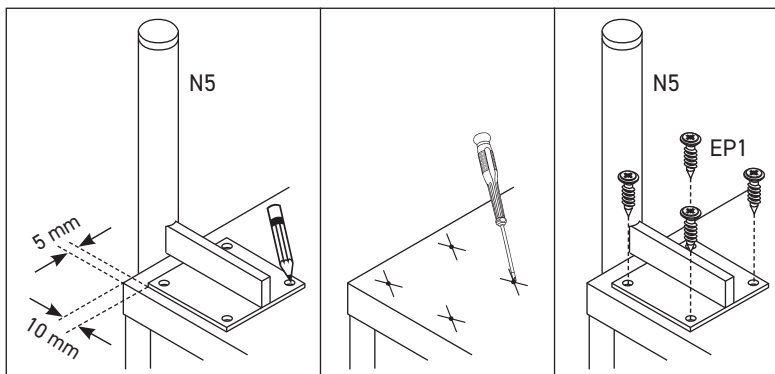
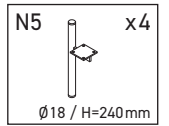
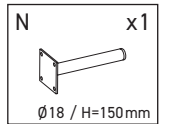
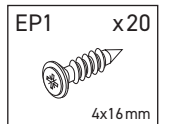
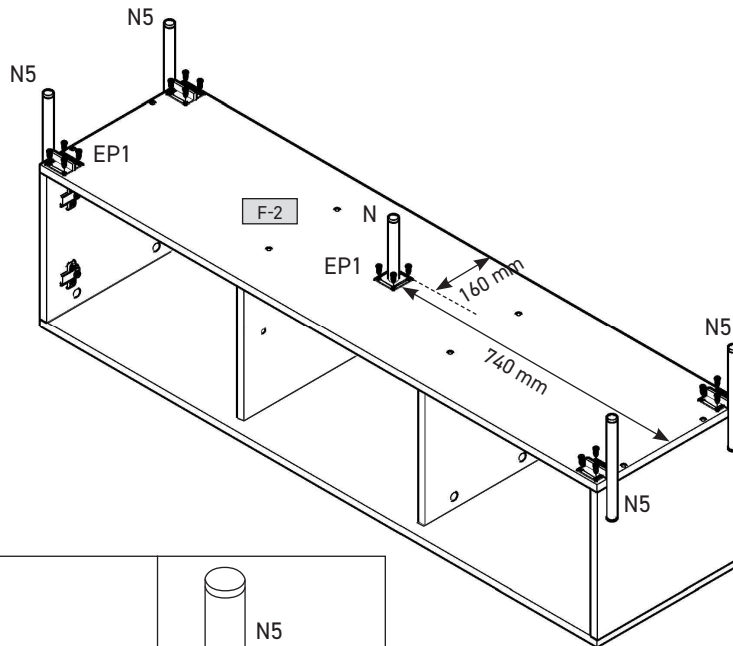

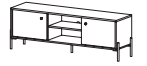

7

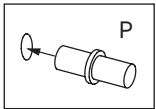
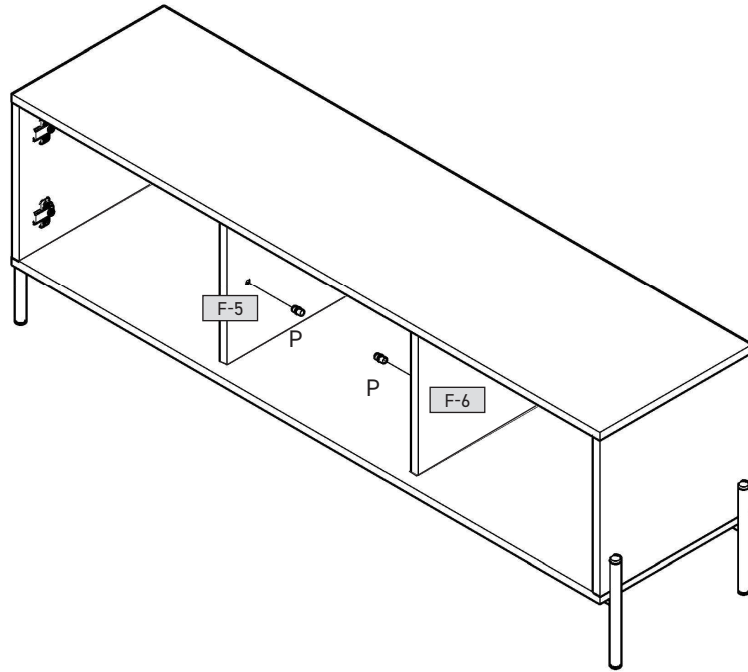
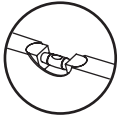
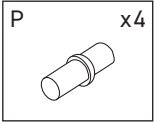

8

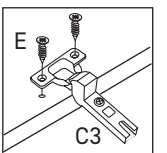
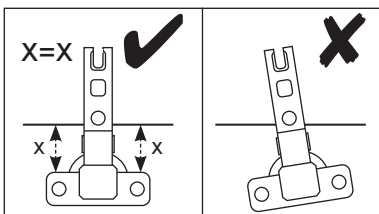
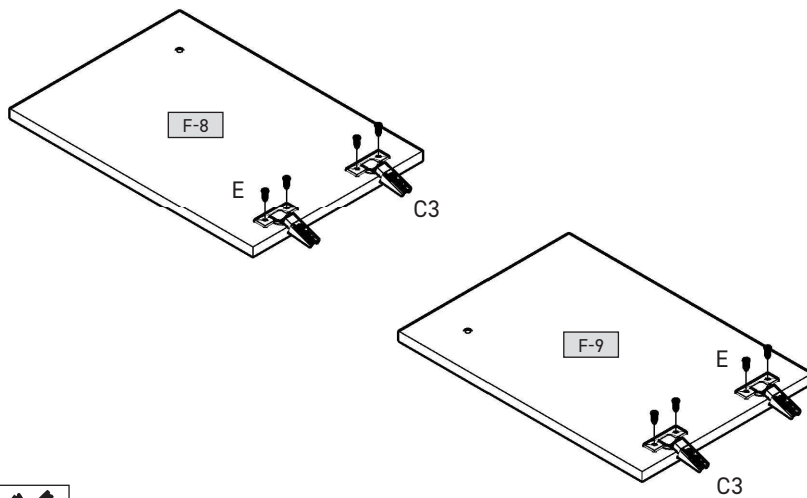
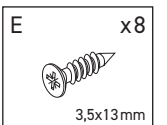
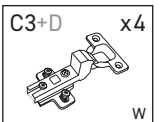





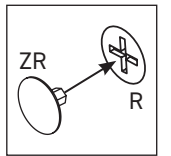
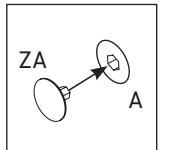
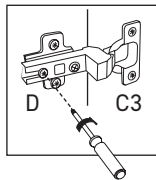
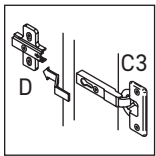
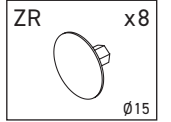
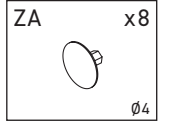
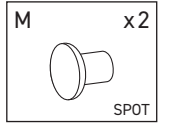
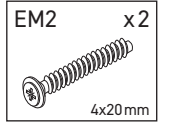
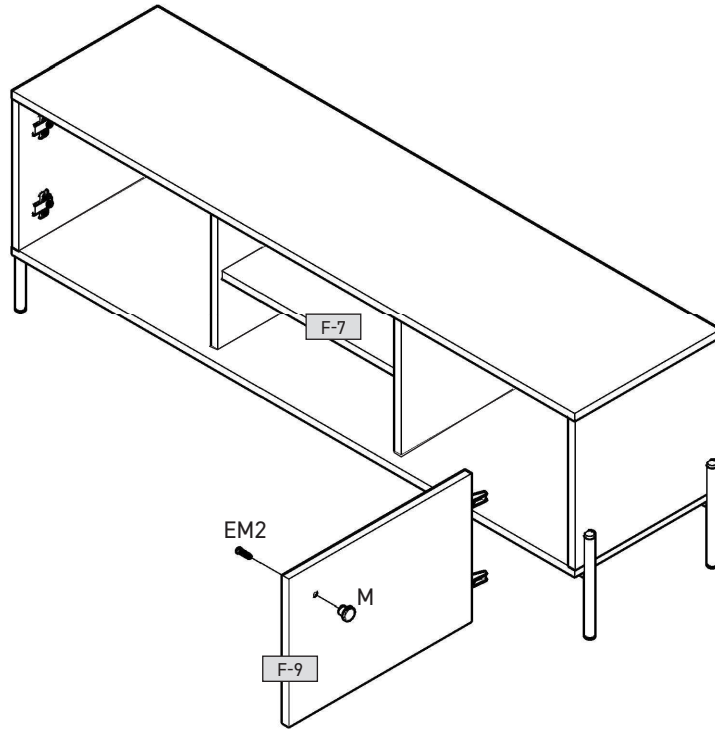
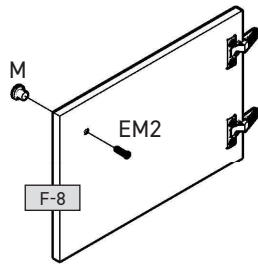



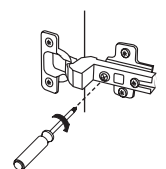
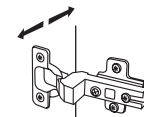
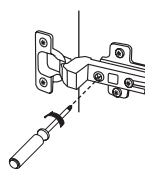
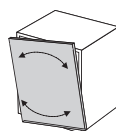
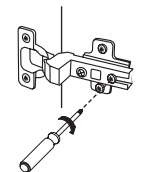
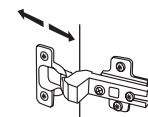
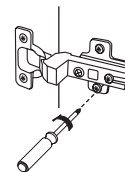
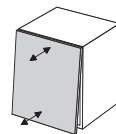
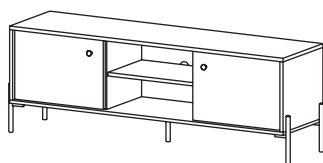
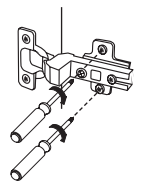
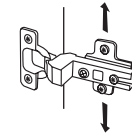
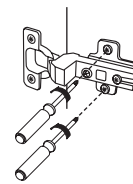
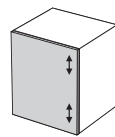

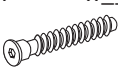





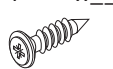

9



10



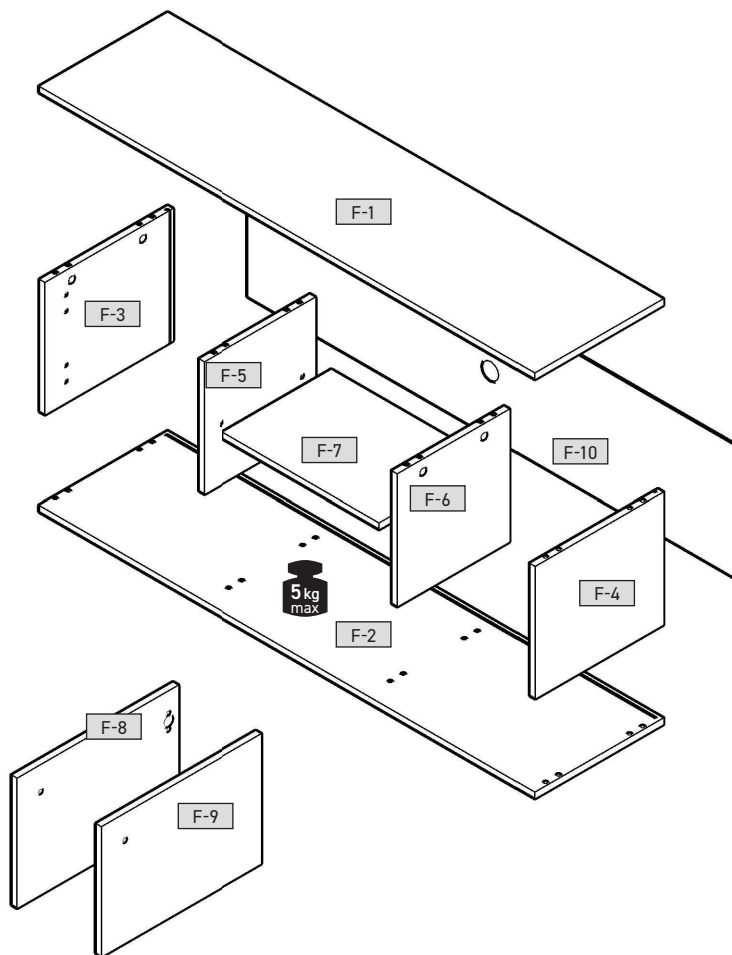

A x__  7x50mm	B x__  8x32mm	C3+D x__  W	E x__  3,5x13mm	E2 x__  3x20mm	EM2 x__  4x20mm	EP1 x__  4x16mm	H1 x__ 	M x__  SPOT
N x__  Ø18 / H=150mm	N5 x__  Ø18 / H=240mm	P x__ 	R x__  H=11mm	U x__  L=24,3mm	XA x__ 	ZA x__  Ø4	ZR x__  Ø15	

F-1	1531	395	16	x1	1/2
F-2	1531	395	16	x1	1/2
F-3	352	394	16	x1	1/2
F-4	352	394	16	x1	1/2
F-5	352	345	16	x1	1/2
F-6	352	345	16	x1	1/2
F-7	482	335	16	x1	1/2
F-8	346	496	16	x1	1/2
F-9	346	496	16	x1	1/2
F-10	1512	366	3	x1	1/2



2/2

N x1  Ø18 / H=150mm	N5 x4  Ø18 / H=240mm
--	---

